

# PC901V0NSZX Series

Digital Output, Normal ON  
Operation DIP 6 pin \*OPIC  
Photocoupler

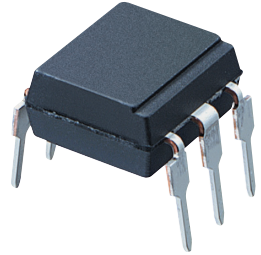

## ■ Description

**PC901V0NSZX Series** contains an IRED optically coupled to an OPIC chip.

It is packaged in a 6 pin DIP.

Input-output isolation voltage(rms) is 5.0kV.

## ■ Features

1. 6 pin DIP package
2. Double transfer mold package  
(Ideal for Flow Soldering)
3. Normal ON operation, open collector output
4. TTL and LSTTL compatible output
5. Operating supply voltage ( $V_{CC}=3$  to 15 V)
6. Isolation voltage ( $V_{iso(rms)}$  : 5.0 kV)

## ■ Agency approvals/Compliance

1. Recognized by UL1577 (Double protection isolation), file No. E64380 (as model No. **PC901V**)
2. Approved by TÜV (VDE0884) (as an option) file No. R2050948 (as model No. **PC901V**)
3. Package resin : UL flammability grade (94V-0)

## ■ Applications

1. Programmable controllers
2. PC peripherals
3. Electronic musical instruments

\* "OPIC"(Optical IC) is a trademark of the SHARP Corporation. An OPIC consists of a light-detecting element and a signal-processing circuit integrated onto a single chip.

Notice The content of data sheet is subject to change without prior notice.  
In the absence of confirmation by device specification sheets, SHARP takes no responsibility for any defects that may occur in equipment using any SHARP devices shown in catalogs, data books, etc. Contact SHARP in order to obtain the latest device specification sheets before using any SHARP device.

## Internal Connection Diagram

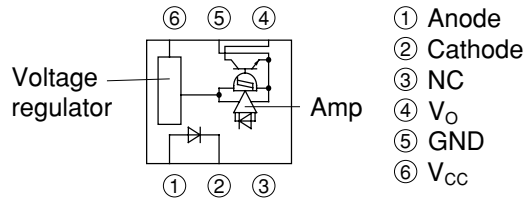

## Outline Dimensions

(Unit : mm)

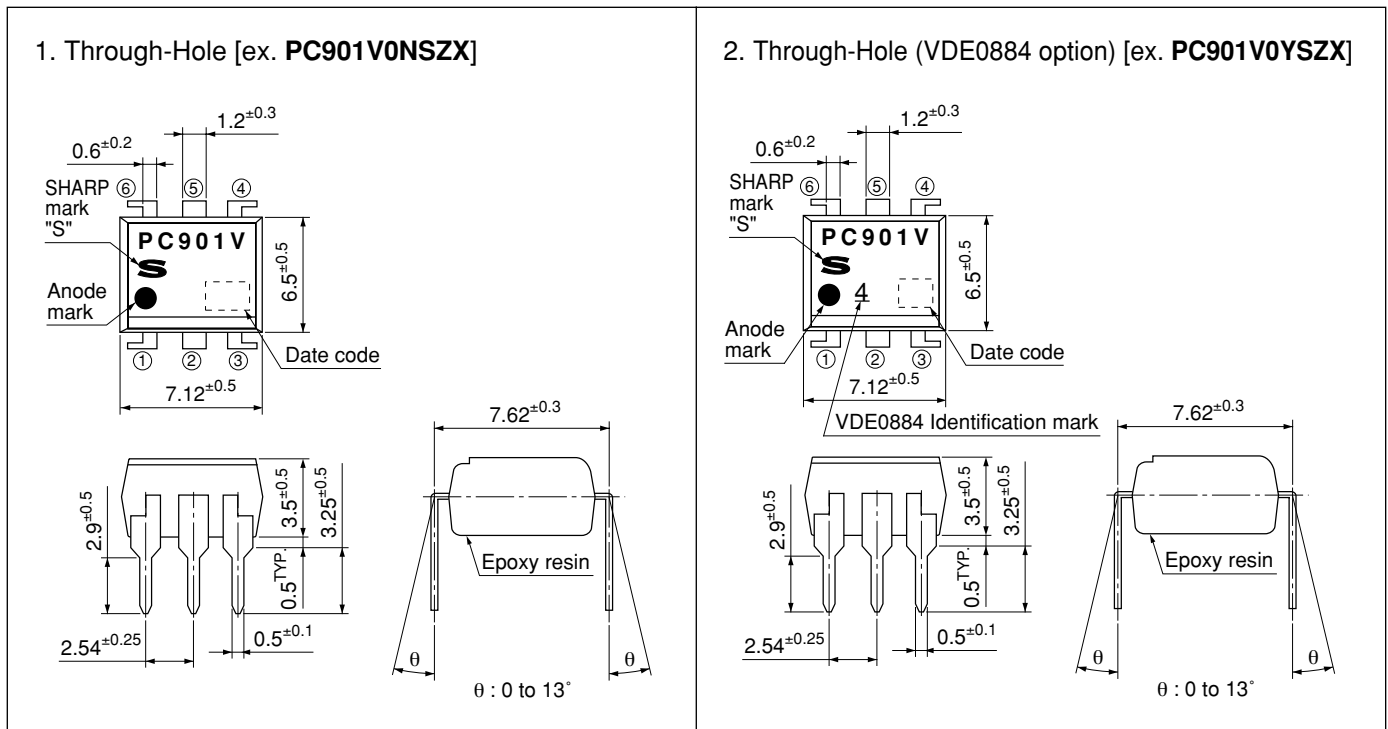

Product mass : approx. 0.36g

Date code (2 digit)

1st digit				2nd digit	
Year of production				Month of production	
A.D.	Mark	A.D	Mark	Month	Mark
1990	A	2002	P	January	1
1991	B	2003	R	February	2
1992	C	2004	S	March	3
1993	D	2005	T	April	4
1994	E	2006	U	May	5
1995	F	2007	V	June	6
1996	H	2008	W	July	7
1997	J	2009	X	August	8
1998	K	2010	A	September	9
1999	L	2011	B	October	O
2000	M	2012	C	November	N
2001	N	∴	∴	December	D

repeats in a 20 year cycle

Country of origin

Japan

## ■ Absolute Maximum Ratings (T<sub>a</sub>=25°C)

Parameter	Symbol	Rating	Unit	
Input	Forward current	I <sub>F</sub>	50	mA
	*1 Peak forward current	I <sub>FM</sub>	1	A
	Reverse voltage	V <sub>R</sub>	6	V
	Power dissipation	P	70	mW
Output	Supply voltage	V <sub>CC</sub>	16	V
	High level output voltage	V <sub>OH</sub>	16	V
	Low level output current	I <sub>OL</sub>	50	mA
	Power dissipation	P <sub>O</sub>	150	mW
Total power dissipation	P <sub>tot</sub>	170	mW	
Operating temperature	T <sub>opr</sub>	-25 to +85	°C	
Storage temperature	T <sub>stg</sub>	-40 to +125	°C	
*2 Isolation voltage	V <sub>iso (rms)</sub>	5.0	kV	
*3 Soldering temperature	T <sub>sol</sub>	260	°C	

\*1 Pulse width ≤ 100μs, Duty ratio : 0.001

\*2 40 to 60%RH, AC for 1 minute, f=60Hz

\*3 For 10s

## ■ Electro-optical Characteristics

(unless otherwise specified T<sub>a</sub>=0 to +70°C)

Parameter		Symbol	Conditions	MIN.	TYP.	MAX.	Unit
Input	Forward voltage	V <sub>F</sub>	I <sub>F</sub> =4mA	-	1.1	1.4	V
			I <sub>F</sub> =0.3mA	0.7	1.0	-	
	Reverse current	I <sub>R</sub>	T <sub>a</sub> =25°C, V <sub>R</sub> =4V	-	-	10	μA
	Terminal capacitance	C <sub>t</sub>	T <sub>a</sub> =25°C, V=0, f=1kHz	-	30	250	pF
Output	Operating supply voltage	V <sub>CC</sub>	-	3	-	15	V
	Low level output voltage	V <sub>OL</sub>	I <sub>OL</sub> =16mA, V <sub>CC</sub> =5V, I <sub>F</sub> =0	-	0.2	0.4	V
	High level output current	I <sub>OH</sub>	V <sub>O</sub> =V <sub>CC</sub> =15V, I <sub>F</sub> =4mA	-	-	100	μA
	Low level supply current	I <sub>CC</sub>	V <sub>CC</sub> =5V, I <sub>F</sub> =0	-	2.5	5.0	mA
	High level supply current	I <sub>CC</sub>	V <sub>CC</sub> =5V, I <sub>F</sub> =4mA	-	2.7	5.5	mA
	*4 "Low→High" input threshold current	I <sub>FLH</sub>	T <sub>a</sub> =25°C, V <sub>CC</sub> =5V, R <sub>L</sub> =280Ω	-	1.1	2.0	mA
			V <sub>CC</sub> =5V, R <sub>L</sub> =280Ω	-	-	4.0	
	*5 "High→Low" input threshold current	I <sub>FHL</sub>	T <sub>a</sub> =25°C, V <sub>CC</sub> =5V, R <sub>L</sub> =280Ω	0.4	0.8	-	mA
			V <sub>CC</sub> =5V, R <sub>L</sub> =280Ω	0.3	-	-	
	*6 Hysteresis	I <sub>FHL</sub> /I <sub>FLH</sub>	V <sub>CC</sub> =5V, R <sub>L</sub> =280Ω	0.5	0.7	0.9	-
Isolation voltage	R <sub>ISO</sub>	T <sub>a</sub> =25°C, DC500V, 40 to 60%RH	5×10 <sup>10</sup>	1×10 <sup>11</sup>	-	Ω	
Transfer characteristics	Response time	"Low→High" propagation delay time	T <sub>a</sub> =25°C V <sub>CC</sub> =5V, I <sub>F</sub> =4mA R <sub>L</sub> =280Ω	-	1	3	μs
		"High→Low" propagation delay time		-	2	6	
		Rise time		-	0.1	0.5	
		Fall time		-	0.05	0.5	
	Instantaneous common mode rejection voltage "Output : High level"	CM <sub>H</sub>	V <sub>CM</sub> =600V(peak), V <sub>O</sub> (MIN.)=2V I <sub>F</sub> =4mA, R <sub>L</sub> =280Ω, T <sub>a</sub> =25°C	-	-2 000	-	V/μs
	Instantaneous common mode rejection voltage "Output : Low level"	CM <sub>L</sub>	V <sub>CM</sub> =600V(peak), V <sub>O</sub> (MAX.)=0.8V I <sub>F</sub> =0, R <sub>L</sub> =280Ω, T <sub>a</sub> =25°C	-	2 000	-	V/μs

\*4 I<sub>FLH</sub> represents forward current when output goes from low to high.

\*5 I<sub>FHL</sub> represents forward current when output goes from high to low.

\*6 Hysteresis stands for I<sub>FHL</sub>/I<sub>FLH</sub>.

**■ Model Line-up**

Lead Form	Through-Hole	
Package	Sleeve	
	50 pcs/sleeve	
VDE0884	———	Approved
Model No.	<b>PC901V0NSZX</b>	<b>PC901V0YSZX</b>

Please contact a local SHARP sales representative to inquire about production status and Lead-Free options.

**Fig.1 Test Circuit for Response Time**

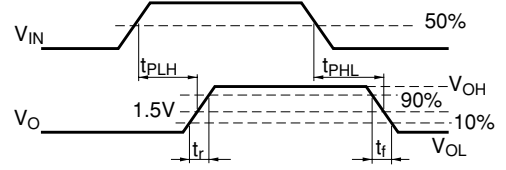
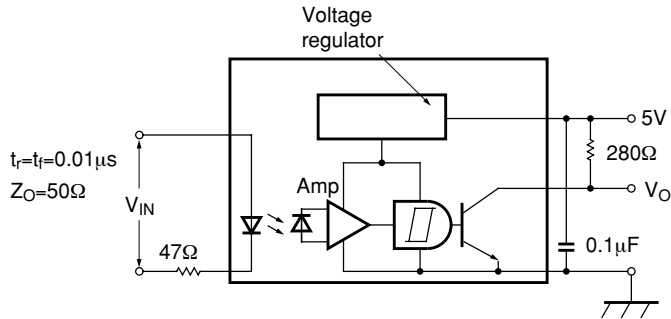

**Fig.2 Test Circuit for Instantaneous Common Mode Rejection Voltage**

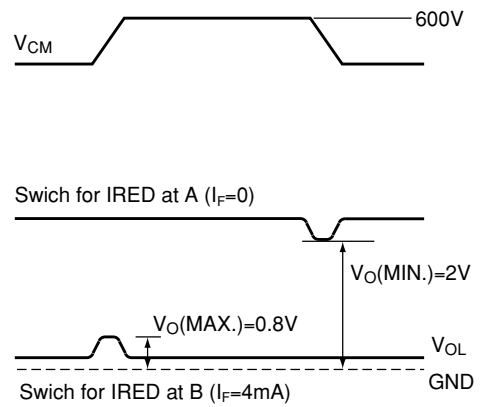
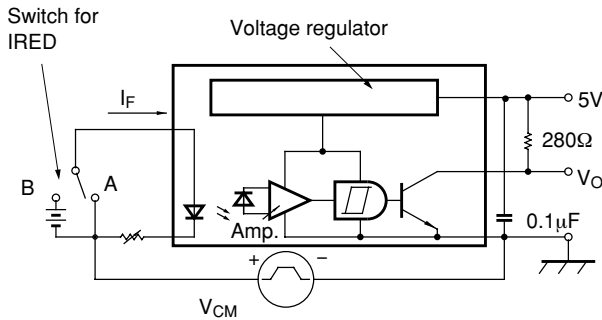

**Fig.3 Forward Current vs. Ambient Temperature**

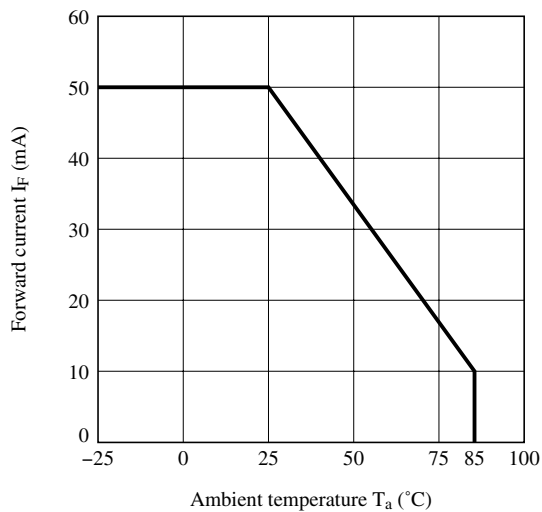

**Fig.4 Power Dissipation vs. Ambient Temperature**

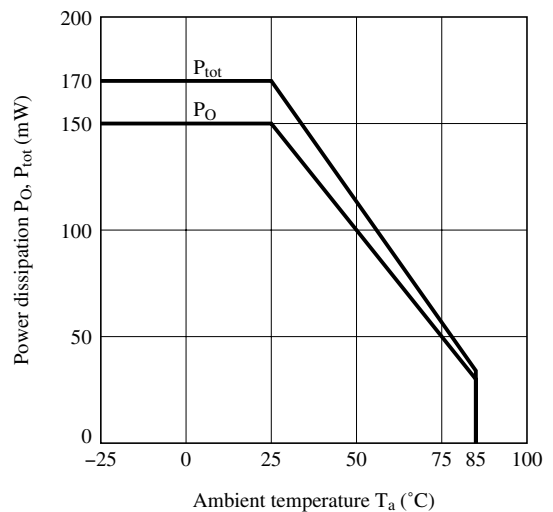

**Fig.5 Forward Current vs. Forward Voltage**

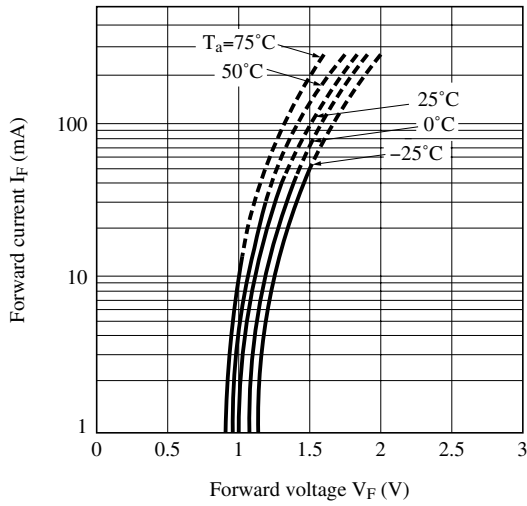

**Fig.6 Relative Input Threshold Current vs. Supply Voltage**

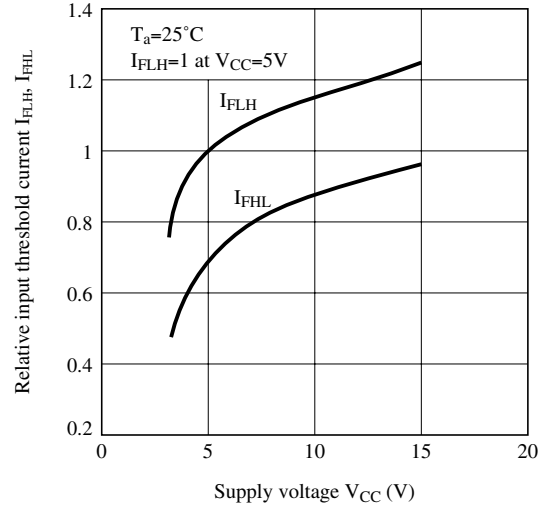

**Fig.7 Relative Input Threshold Current vs. Ambient Temperature**

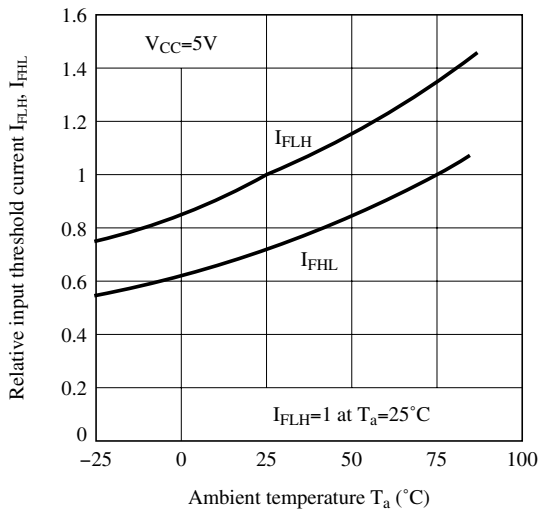

**Fig.8 Low Level Output Voltage vs. Low Level Output Current**

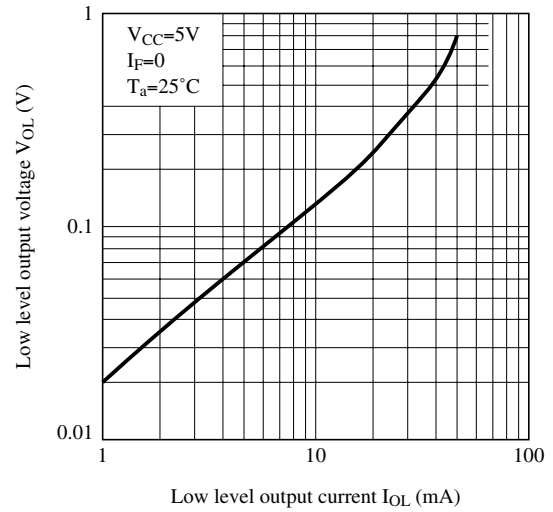

**Fig.9 Low Level Output Voltage vs. Ambient Temperature**

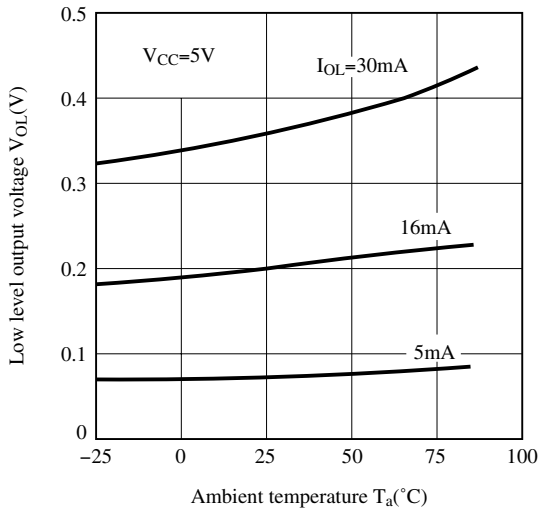

**Fig.10 High Level Output Current vs. Forward Current**

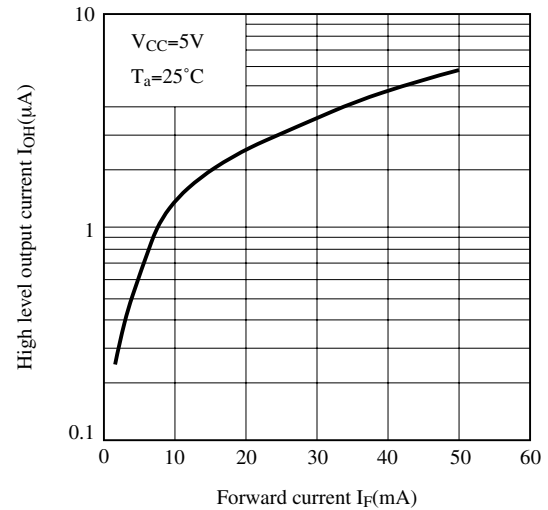

**Fig.11 High Level Output Current vs. Ambient Temperature**

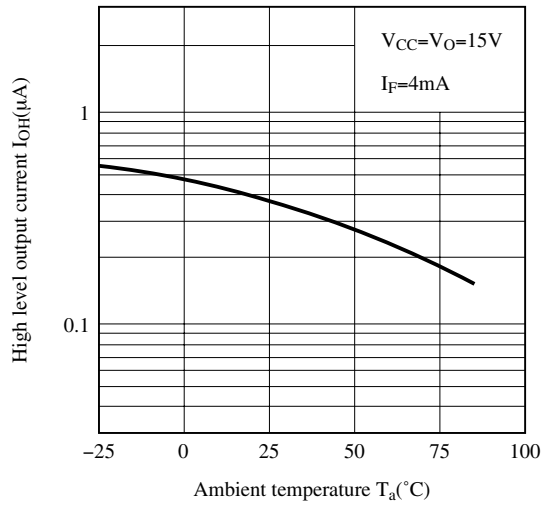

**Fig.12 Supply Current vs. Supply Voltage**

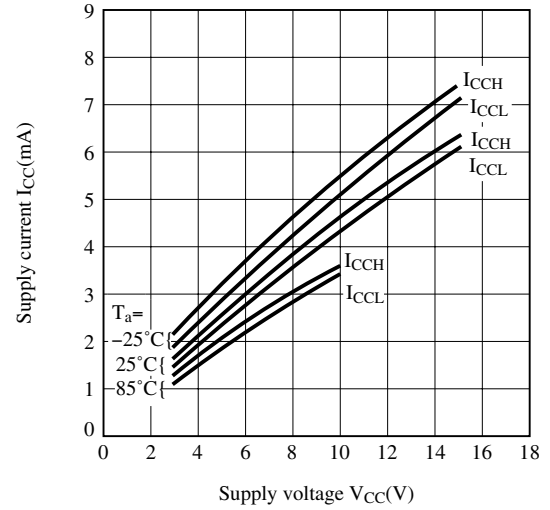

**Fig.13 Propagation Delay Time vs. Forward Current**

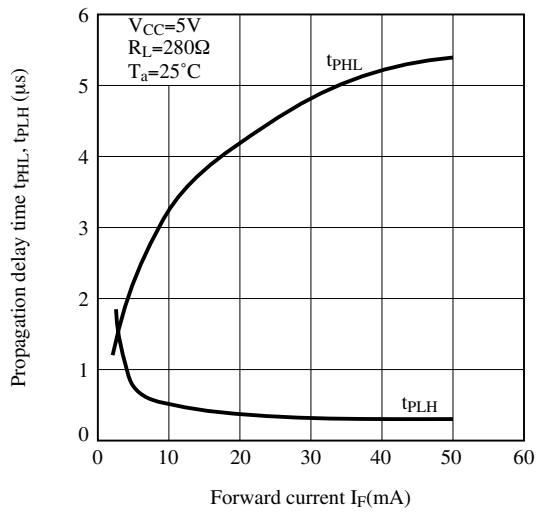

**Fig.14 Rise Time, Fall Time vs. Load Resistance**

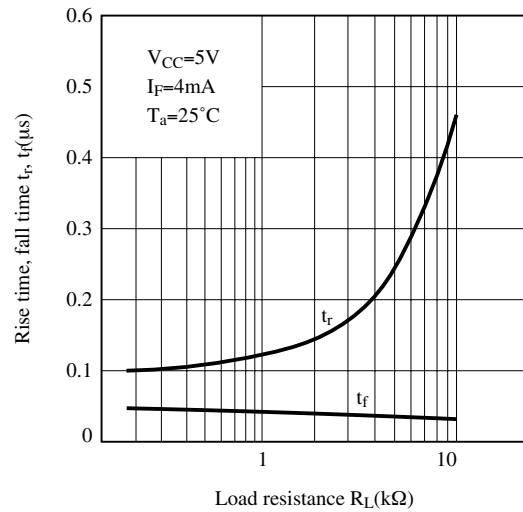

Remarks : Please be aware that all data in the graph are just for reference and not for guarantee.



## ■ Design Considerations

### ● Notes about static electricity

Transistor of detector side in bipolar configuration may be damaged by static electricity due to its minute design.

When handling these devices, general countermeasure against static electricity should be taken to avoid breakdown of devices or degradation of characteristics.

### ● Design guide

In order to stabilize power supply line, we should certainly recommend to connect a by-pass capacitor of 0.01 $\mu$ F or more between  $V_{CC}$  and GND near the device.

In case that some sudden big noise caused by voltage variation is provided between primary and secondary terminals of photocoupler some current caused by it is floating capacitance may be generated and result in false operation since current may go through IRED or current may change.

If the photocoupler may be used under the circumstances where noise will be generated we recommend to use the bypass capacitors at the both ends of IRED.

The detector which is used in this device, has parasitic diode between each pins and GND.

There are cases that miss operation or destruction possibly may be occurred if electric potential of any pin becomes below GND level even for instant.

Therefore it shall be recommended to design the circuit that electric potential of any pin does not become below GND level.

This product is not designed against irradiation and incorporates non-coherent IRED.

### ● Degradation

In general, the emission of the IRED used in photocouplers will degrade over time.

In the case of long term operation, please take the general IRED degradation (50% degradation over 5years) into the design consideration.

Please decide the input current which become 2times of MAX.  $I_{FLH}$ .

**■ Manufacturing Guidelines****● Soldering Method****Flow Soldering :**

Due to SHARP's double transfer mold construction submersion in flow solder bath is allowed under the below listed guidelines.

Flow soldering should be completed below 270°C and within 10s.

Preheating is within the bounds of 100 to 150°C and 30 to 80s.

Please don't solder more than twice.

**Hand soldering**

Hand soldering should be completed within 3s when the point of solder iron is below 400°C.

Please don't solder more than twice.

**Other notices**

Please test the soldering method in actual condition and make sure the soldering works fine, since the impact on the junction between the device and PCB varies depending on the tooling and soldering conditions.

**● Cleaning instructions****Solvent cleaning:**

Solvent temperature should be 45°C or below Immersion time should be 3minutes or less

**Ultrasonic cleaning:**

The impact on the device varies depending on the size of the cleaning bath, ultrasonic output, cleaning time, size of PCB and mounting method of the device.

Therefore, please make sure the device withstands the ultrasonic cleaning in actual conditions in advance of mass production.

**Recommended solvent materials:**

Ethyl alcohol, Methyl alcohol and Isopropyl alcohol

In case the other type of solvent materials are intended to be used, please make sure they work fine in actual using conditions since some materials may erode the packaging resin.

**● Presence of ODC**

This product shall not contain the following materials.

And they are not used in the production process for this device.

Regulation substances : CFCs, Halon, Carbon tetrachloride, 1.1.1-Trichloroethane (Methylchloroform)

Specific brominated flame retardants such as the PBBOs and PBBs are not used in this product at all.

■ **Package specification**

● **Sleeve package**

Package materials

Sleeve : HIPS (with anti-static material)

Stopper : Styrene-Elastomer

Package method

MAX. 50 pcs. of products shall be packaged in a sleeve.

Both ends shall be closed by tabbed and tabless stoppers.

The product shall be arranged in the sleeve with its anode mark on the tabless stopper side.

MAX. 20 sleeves in one case.

Sleeve outline dimensions

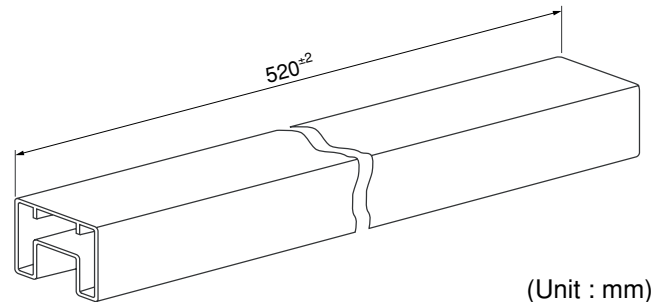
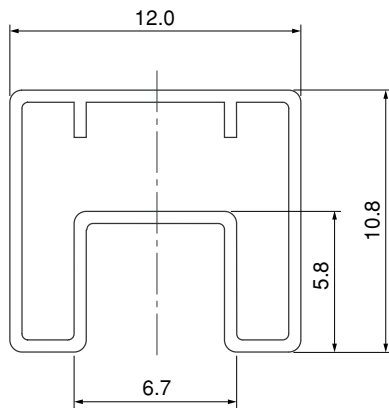

## ■ Important Notices

· The circuit application examples in this publication are provided to explain representative applications of SHARP devices and are not intended to guarantee any circuit design or license any intellectual property rights. SHARP takes no responsibility for any problems related to any intellectual property right of a third party resulting from the use of SHARP's devices.

· Contact SHARP in order to obtain the latest device specification sheets before using any SHARP device. SHARP reserves the right to make changes in the specifications, characteristics, data, materials, structure, and other contents described herein at any time without notice in order to improve design or reliability. Manufacturing locations are also subject to change without notice.

· Observe the following points when using any devices in this publication. SHARP takes no responsibility for damage caused by improper use of the devices which does not meet the conditions and absolute maximum ratings to be used specified in the relevant specification sheet nor meet the following conditions:

(i) The devices in this publication are designed for use in general electronic equipment designs such as:

- Personal computers
- Office automation equipment
- Telecommunication equipment [terminal]
- Test and measurement equipment
- Industrial control
- Audio visual equipment
- Consumer electronics

(ii) Measures such as fail-safe function and redundant design should be taken to ensure reliability and safety when SHARP devices are used for or in connection

with equipment that requires higher reliability such as:

- Transportation control and safety equipment (i.e., aircraft, trains, automobiles, etc.)
- Traffic signals
- Gas leakage sensor breakers
- Alarm equipment
- Various safety devices, etc.

(iii) SHARP devices shall not be used for or in connection with equipment that requires an extremely high level of reliability and safety such as:

- Space applications
- Telecommunication equipment [trunk lines]
- Nuclear power control equipment
- Medical and other life support equipment (e.g., scuba).

· If the SHARP devices listed in this publication fall within the scope of strategic products described in the Foreign Exchange and Foreign Trade Law of Japan, it is necessary to obtain approval to export such SHARP devices.

· This publication is the proprietary product of SHARP and is copyrighted, with all rights reserved. Under the copyright laws, no part of this publication may be reproduced or transmitted in any form or by any means, electronic or mechanical, for any purpose, in whole or in part, without the express written permission of SHARP. Express written permission is also required before any use of this publication may be made by a third party.

· Contact and consult with a SHARP representative if there are any questions about the contents of this publication.